

2.4G LED RGB Controller



Main Characteristics

V3 RF RGB Remote Control

- Remote Option: RGB
- Working Voltage: 3Vdc (Battery CR2032)
- Wireless Frequency: 2.4GHz
- Visual Distance: 30m
- Working Temperature: -30°C-55°C
- Package Size: L150×W46×H18(mm)
- Weight(G.W.): 80g

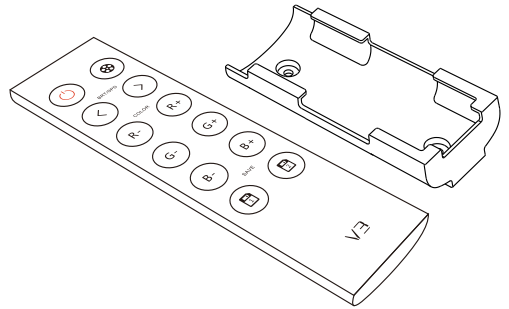

R4-3A CV Receiver

- Input Voltage: 5~24Vdc
- Max Current Load: 3A × 4CH Max. 12A
- Max Output Power: 60W/144W/288W(5V/12V/24V)
- Working Temperature: -30°C-55°C
- Package Size: L125×W33×H20(mm)
- Weight(G.W.): 60g

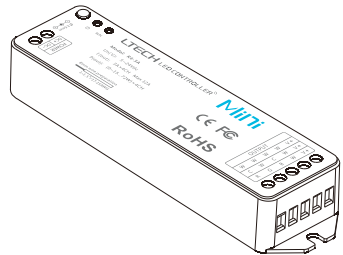

Dimensions

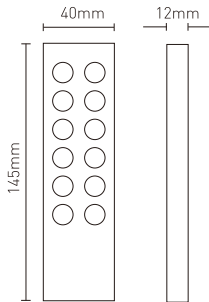

Remote

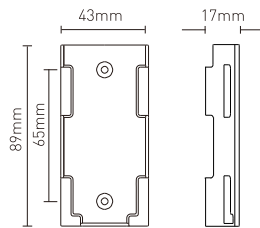

Holder

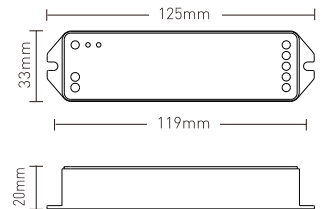

Receiver

Package

Blister package



Individual package

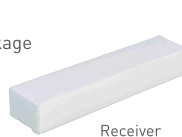

Receiver



Remote

Operating Instruction for Remote:

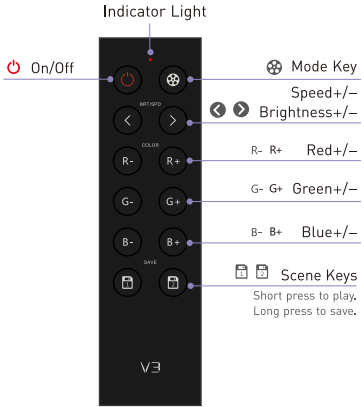

ID learning between the remote and the receiver

Learning ID: Short press "ID learning button" on the R4-3A receiver, the running light keeps on. Then press any key on the remote, the running light on the receiver flicker several times, activated.

Canceling ID: Long press "ID learning button" on the R4-3A receiver for 5 seconds, the running light flicker several times, canceled.

ID Learning between the remotes

Learning ID: Assuming that remote B match up with remote A, first press the two bottom keys of remote B simultaneously until the indicator light keeps on. Then press any key on remote A in 5 seconds. When the indicator of remote B turns off, ID learning is successful.

Canceling ID: Press the two bottom keys of remote B simultaneously (about 6 seconds), the indicator light keeps on, canceled.

The Changing Mode (Press to Switch)

- A. Static Red
- B. Static Green
- C. Static Blue
- D. Static Yellow
- E. Static Purple
- F. Static Cyan
- G. Static White
- H. RGB Skipping
- I. 7 Colors Skipping
- J. RGB Smooth
- K. 7 Colors Smooth

Operating Instruction for Receiver:

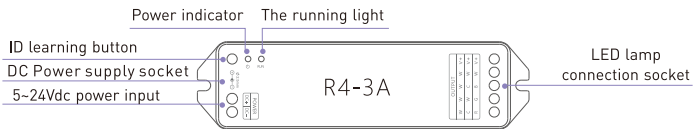

Wiring Diagram :

